

OMIKRON FLOOD

220-240V 50/60Hz

IP66 IK09



Dimensioni - Dimensions:

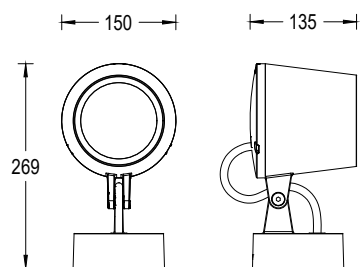

Peso - Weight (kg)	2
SC front (m ²)	0,024
SC side (m ²)	0,026

Strumenti - Tools:

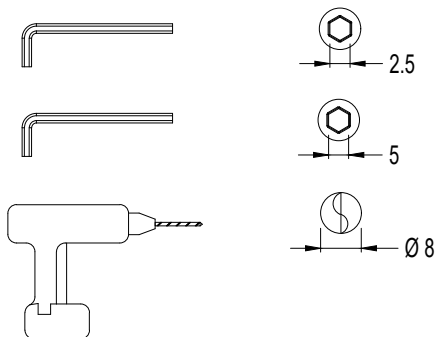

1. Rimuovere la base - remove the base:

1.1 allentare il grano
loosen the socket set screw

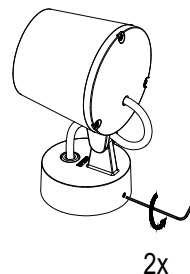

1.1 ruotare e rimuovere la base
rotate and remove the base

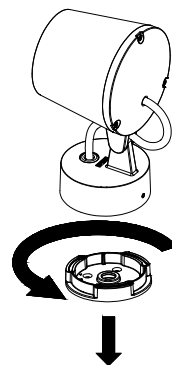

2. parete / terra / soffitto

wall / ground / ceiling
Usare tasselli ad espansione per il fissaggio della base alla superficie.
Use anchor fixing to fix the base to the surface.

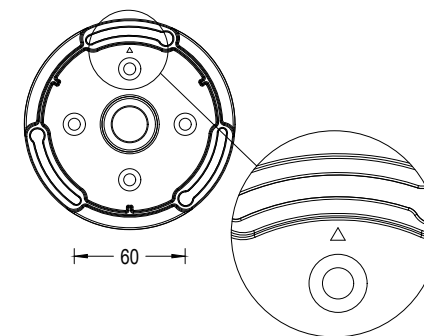
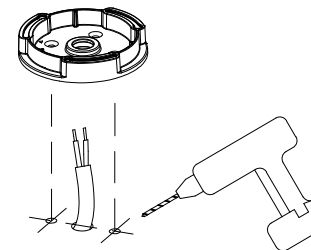

Direzione emissione luminosa
Light emission direction

3. Connettere il prodotto alla rete con un connettore stagno

Plug the product to the main line using a waterproof cable clamp

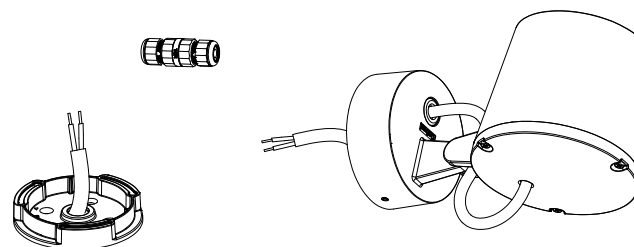

3.1 Connessione - Cabling:

CLASSE II / CLASS II

MARRONE / BROWN - L
BLU / BLUE - N

GRIGIO / GREY - (DA+)
NERO / BLACK - (DA-)

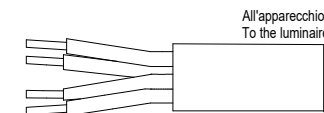

3.2 Connettore stagno / waterproof cable clamp cod. 060M906C0 (optional):

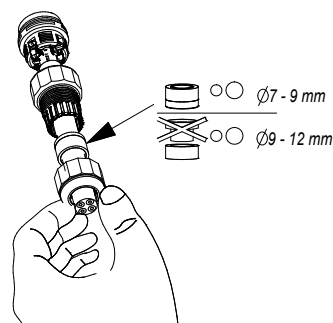

1 - L
2 - N
3 - (DA+)
4 - (DA-)

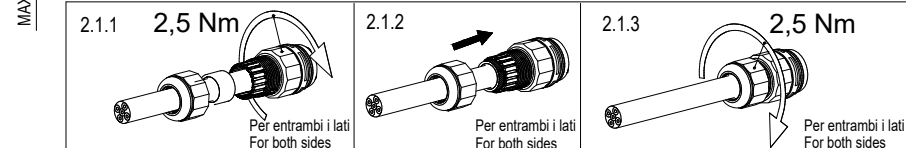
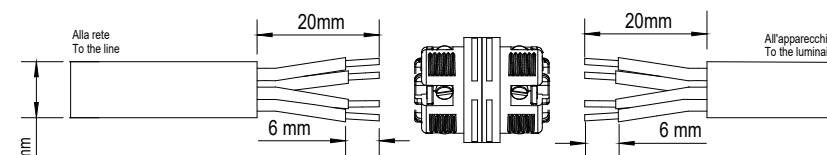

4. Fissaggio del prodotto - Product fastening:

4.1 Alloggiare il connettore all'interno della base e posizionare il proiettore.
Fit the connector inside the base and mount the projector on the base.

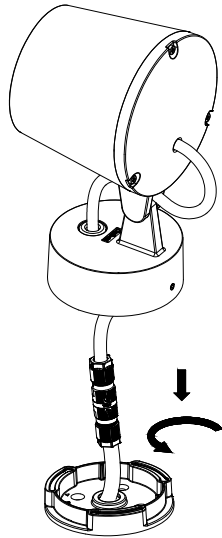

4.2 Regolare l'orientamento del prodotto
Adjust product orientation

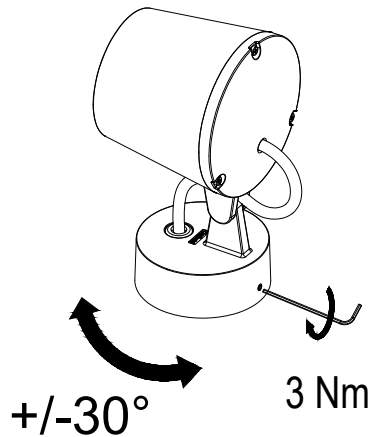

5. Avvertenze - Warnings :

Regolare l'inclinazione del prodotto
Adjust product angle

+90°  -45°

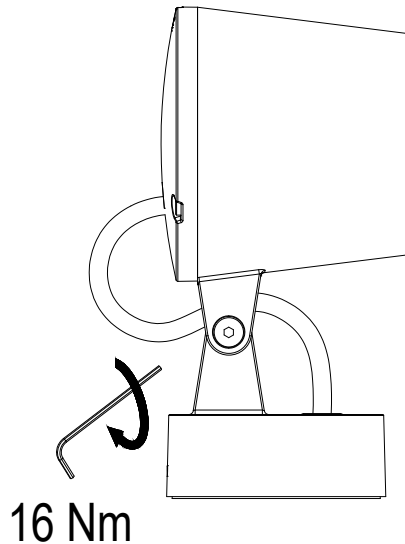

Pulire la superficie del vetro
Clean the glass surface

- IT** L'installazione necessita l'intervento di personale specializzato. La sorgente luminosa contenuta in questo apparecchio deve essere sostituita solo dal costruttore o dal suo servizio di assistenza o da personale altrettanto qualificato. **ATTENZIONE!! PERICOLO DI SCOSSA ELETTRICA, PRIMA DI EFFETTUARE OPERAZIONI DI MONTAGGIO O MANUTENZIONE TOGLIERE LA TENSIONE.** In caso di rottura del vetro, l'apparecchio deve essere riparato esclusivamente dal costruttore. Conservare l'etichetta d'imballo per l'identificazione dell'apparecchio in caso di reclamo. L'apparecchio di illuminazione dovrebbe essere posizionato in modo che non sia prevista un'osservazione prolungata dell'apparecchio a una distanza inferiore a 2,15m (IEC/TR 62778:2014). Adatto al funzionamento in interni. L'apparecchio non deve, in alcuna circostanza, essere coperto con materiale isolante o similare.
- EN** The installation must be carried out by qualified technicians. The light source contained in this luminaire shall only be replaced by the manufacturer or his service agent or a similar qualified person. **WARNING!! DANGER OF ELECTRIC SHOCK, DISCONNECT FROM ELECTRICAL SUPPLY DURING INSTALLATION OR MAINTENANCE.** In case of glass-fissure, the appliance should be serviced only by the manufacturer. Keep packing label to identify fitting, in case of claim. The luminaire should be positioned so that prolonged staring into the luminaire at a distance closer than 2,15m is not expected (IEC/TR 62778:2014). Suitable for indoor installation. The fitting shouldn't in any case be covered with any insulating material or similar.
- FR** L'installation doit être faite par personnel compétent. La source lumineuse utilisée dans cet appareil peut être remplacée uniquement par le producteur, son service d'assistance ou par du personnel aussi qualifié. **ATTENTION!! DANGER DE CHOC ELECTRIQUE, COUPER L'ALIMENTATION ÉLECTRIQUE AVANT INSTALLATION OU ENTRETIEN.** En cas de rupture verre, l'appareil doit être réparé que par le fabricant. Garder l'étiquette emballage pour l'identification de l'appareil en cas de réclamation. Il faudrait placer l'appareil d'éclairage de façon que l'observation prolongée de l'appareil d'une distance inférieure à 2,15m soit évitée (IEC/TR 62778:2014). Indiqué pour installation à l'intérieur. L'appareil ne doit en aucun cas être recouvert d'un matériau isolant ou similaire.
- DE** Die Installation soll von Fachpersonal gemacht werden. Der Ersatz der vorhandenen Lichtquelle soll ausschließlich durch den Hersteller oder Fachpersonal der Lieferanten vorgenommen werden. **ACHTUNG!! GEFAHR VON ELEKTRISCHER SCHLAG, STROMNETZ TRENNEN VOR INSTALLATION ODER BEI WARTUNGSARBEITEN.** Im Falle eines Glasbruchs, sollte das Gerät nur vom Hersteller bedient werden. Die Behalten Sie Verpackungsetikette für die Identifizierung des Geräts falls es eine Beanstandung entsteht. Die Installation von der Leuchte soll dazu dienen, dass kein längeres Starren beim niedrigen Abstand als 2,15 Meter möglich sei (IEC/TR 62778:2014). Geeignet für die Installation im Innenbereich. Das Gerät darf auf keinen Fall mit Isoliermaterial o.ä. abgedeckt werden.
- ES** La instalación necesita la intervención de personal especializado. La fuente luminosa de este aparato debe ser sustituida solo por el fabricante o por su servicio de asistencia o por personal altamente cualificado. **ATTENCIÓN!! POR PELIGRO DE DESCARGA ELECTRICA, ANTES DE EFECTUAR UNA OPERACION DE MONTAJE O MANUTENCION, DESCONNECTAR LA CORRIENTE ELECTRICA.** En caso de rotura de vidrio, el aparato debe ser reparado por el fabricante. Conservar la etiqueta del embalaje para identificar al aparato en caso de reclamación. El producto de iluminación debe estar posicionado en modo tal que no permita mirarlo directamente de forma prolongada a una distancia inferior a 2,15 metros (IEC/TR 62778:2014). Apto para funcionamiento interior. El aparato no debe estar bajo ninguna circunstancia cubierto con material aislante o similar.